



NX

NX450h+ / NX350h / NX350 / NX250









Design _____ LEXUS NX



Forging next-generation Lexus design

With the NX, Lexus embraced the challenge of establishing the design language for our next generation of vehicles through the 'pursuit of originality rooted in proportions' and the 'pursuit of simplicity rooted in technology,' creating a solid form and sharpness that are uniquely Lexus in an original package based on dynamic performance. In the NX exterior, it is expressed in the solid, dynamic character and seductively sculpted form derived from the change in platform.

The interior aims to express the appeal of innovative functions and technology through simple design. Reflecting this approach, the cabin draws on the Tazuna Concept, a philosophy based on the creation of a space that extends 'omotenashi' hospitality to individual occupants, and creates intuitive connections between car and driver to facilitate concentration on driving operations.



A cockpit based on the Tazuna Concept

The Tazuna Concept embodies the further evolution of the human-centered philosophy rooted in Lexus's approach to automotive design. Inspired by Tazuna, Japanese for the reins of a horse, it seeks to foster robust communication between driver and car. Applying the Tazuna Concept, the development of the cockpit aims to deepen communication with the car, so drivers can experience the joy of controlling a vehicle that responds precisely to their intentions. In approaching the design, engineers pursued innovative technology with simple appeal. Through the placement and form of information-related components that connect the cabin with the road ahead, the cockpit fosters awareness of what lies in front of the vehicle while facilitating smooth eye movements. The layout of information-related components leads the line-of-sight longitudinally from the color head-up display to the meters, while components have been arranged to lead the eye from the head-up display to the center display, for smooth line-of-sight movement. In addition, by consolidating driving-related functions around the steering wheel, the cockpit aims to provide intuitive, effortless driving control.



The front profile expresses the NX's originality

Spindle grille

The taut and compact design enhances the condensed impression of the spindle grille, creating a pushed-forward look and simplifying construction while reducing weight. The grille pattern features tall U-shaped blocks with a three-dimensional sense of depth, to express a powerful look. A slit-shaped opening at the bottom enhances cooling performance, and communicates a sense of power befitting an SUV.



Headlamps

The 3-eye projector headlamps feature a black extension that creates a more subdued impression, accentuating the signature L-shaped DRL (Daytime Running Lights). The one-lamp projector unit combines an L-shaped DRL and a single Bi-Beam LED unit, creating a sharp look with a powerful expression in a simple design.



3-eye projector headlamp



One-lamp projector headlamp

Strengthening and deepening the Lexus signature

Rear combination lamps

The L-shaped light bar rear combination lamp features a light bar lamp on the rear center and L-shaped lamps positioned independently on the rear fenders, that activate in a phased arrangement to express the unique identity of the NX. At night, the light bar lamp is always lit to act as a tail lamp, further emphasizing the rear brand signature. In addition, the Lexus name logo exudes a sleek, modern image.



The center display supports intuitive operation

Center display

The large center touch display integrates numerous functions in the form of software switches. To enhance intuitive operation, the size, shape, layout, information displayed, placement and other aspects of the switch design were optimized for easy operation, reflecting how often each function is used. In addition, the frequently used air conditioning and audio controls have actual dial switches that allow no-look touch operation.



Simple, easy-to-understand meters and color head-up display

Meters

The meter design reflects the careful placement of content to reliably communicate information while driving. It includes continuous display of navigation route information and estimated time of arrival, driving assist system status, and driving range.

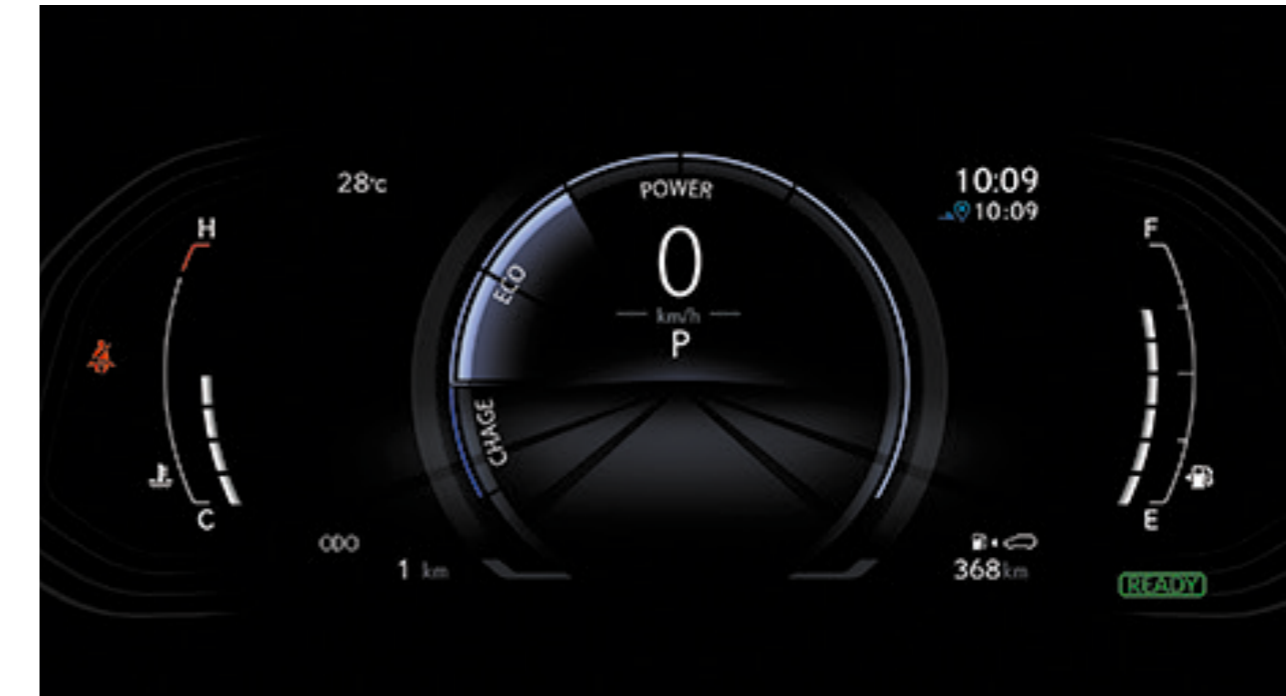

Color head-up display

A color head-up display projects key driving information in the driver's field of view on the windshield glass. Three display modes are provided to enhance driving enjoyment, while maintaining an ample field of view for checking road conditions around the vehicle.

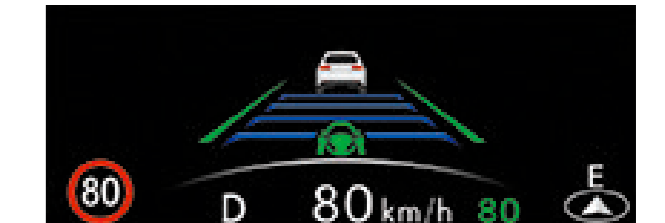

Full: Relaxed driving (when using driving assist systems, etc.) System operational status is displayed in a large, easy-to-understand manner.

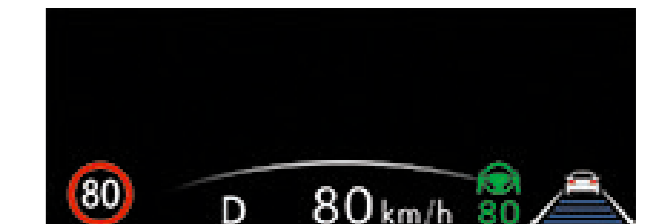

Standard: Enjoyable driving Content is concentrated at the bottom to provide a large field of view.

Note: Vehicles pictured and specifications detailed in this catalog may vary from models and equipment available in your area. Please inquire at your local dealer for details on the availability of features.

Steering switches linked to the color head-up display

Touch tracing operation

The steering wheel features touch tracing operation, which detects where the driver is touching the steering wheel switch and displays operational guidance on the color head-up display. It enables intuitive driving operation while looking ahead, without the need to look down at your hands. When the color head-up display is turned off, this information is displayed in the meter.



Lighting that combines elegance with the spirit of 'omotenashi' hospitality

Interior illumination

Indirect illumination enriches the beautiful forms and materials in the cabin. Illumination throughout the cockpit, including displays and the start switch, imbue the space with color. 14 colors were carefully selected to express the changing emotions and feelings of witnessing beautiful natural phenomena. Gentle color tones with a subdued saturation create expressive illumination with a touch of class worthy of a Lexus, providing a spirit of 'omotenashi' hospitality that resonates on an emotional level. In addition to the theme colors, you can select from 50 additional colors from a color palette that can be displayed in the center display.



Driving Signature

LEXUS NX

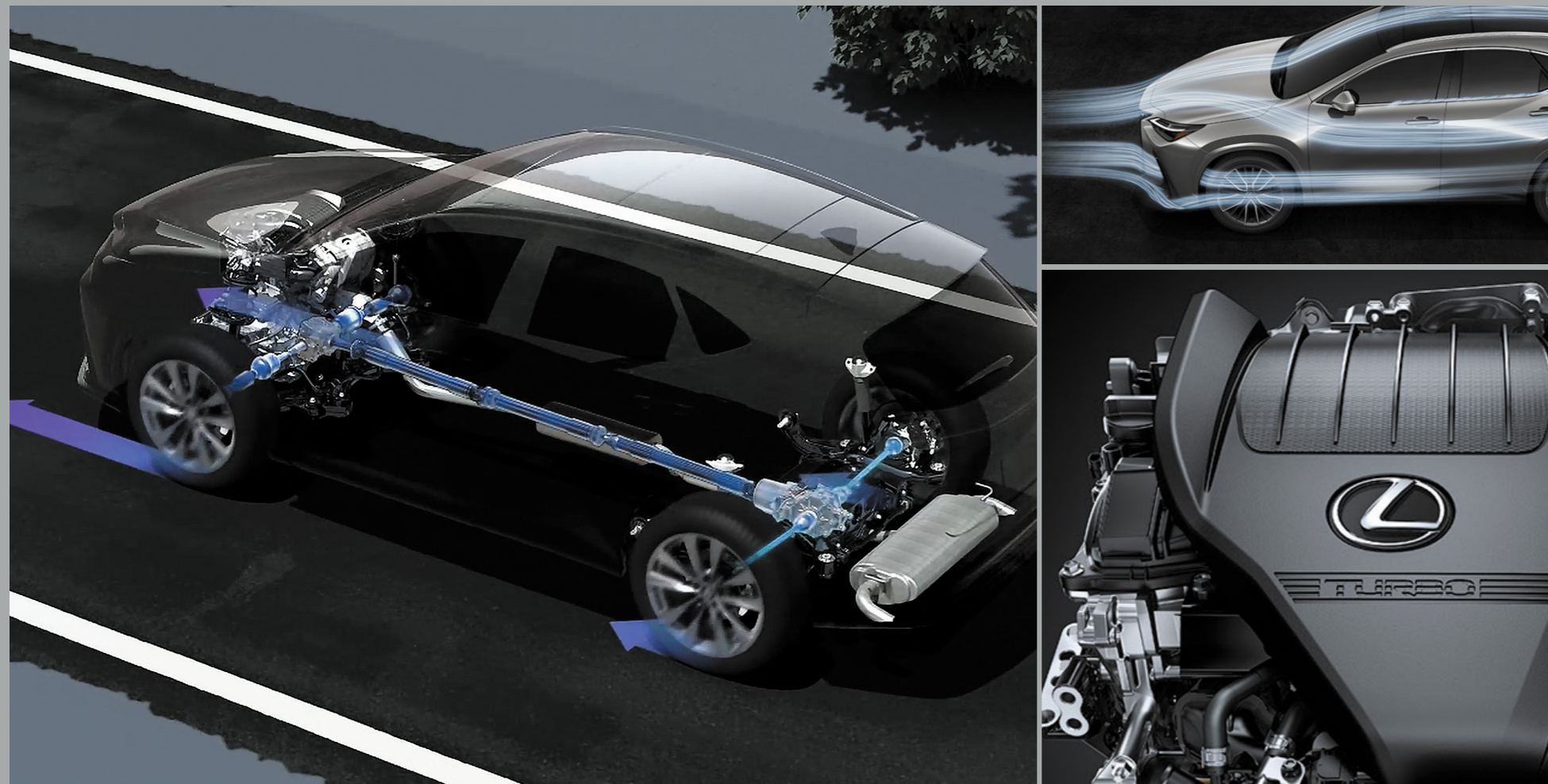

Note: Vehicles pictured and specifications detailed in this catalog may vary from models and equipment available in your area. Please inquire at your local dealer for details on the availability of features.

A pleasingly smooth-revving 2.4-liter turbo engine and smoothly accelerating 2.5-liter engine

2.4-liter L4 turbo engine

The 2.4-liter inline 4-cylinder turbo engine revs pleasantly in response to accelerator input, providing outstanding acceleration response and ample driving power. Based on TNGA engine technology, it features a high-efficiency twin-scroll turbocharger, center direct injection system, and DC motor-controlled variable cooling system. Utilizing the ample torque it delivers powerful, dynamic performance together with excellent environmental performance and low fuel consumption.



2.5-liter L4 engine

The 2.5-liter inline 4-cylinder engine provides linear, smooth acceleration in response to the driver's acceleration operation. It realizes high-speed combustion through the use of high-efficiency intake ports to increase airflow in the combustion chamber. In addition, advanced technologies including multi-hole direct injectors, continuously variable-capacity oil pump, variable cooling system, and VVT-iE further contribute to powerful performance together with outstanding fuel efficiency and a high level of environmental performance.*1



8-speed AT and AWD deliver Lexus's unique brand of driving performance

Direct Shift-8AT

The Direct Shift-8AT, an 8-speed automatic transmission, balances driving performance that's rich in direct feel with excellent fuel economy. Paired with the 2.4-liter turbo engine, it was refined to realize powerful performance with the hallmark low-rpm response of a turbo powerplant. Paired with the 2.5-liter gasoline engine, the gear ratios were optimized to deliver sharp performance together with outstanding fuel economy. The AT's control algorithm anticipates continuously changing road conditions and driver intentions based on control inputs to allow engine output and gear selections that suit the driving environment. It provides excellent fuel economy and quietness while cruising, and heightens driving enjoyment with driver gear selection when you want to drive more actively.

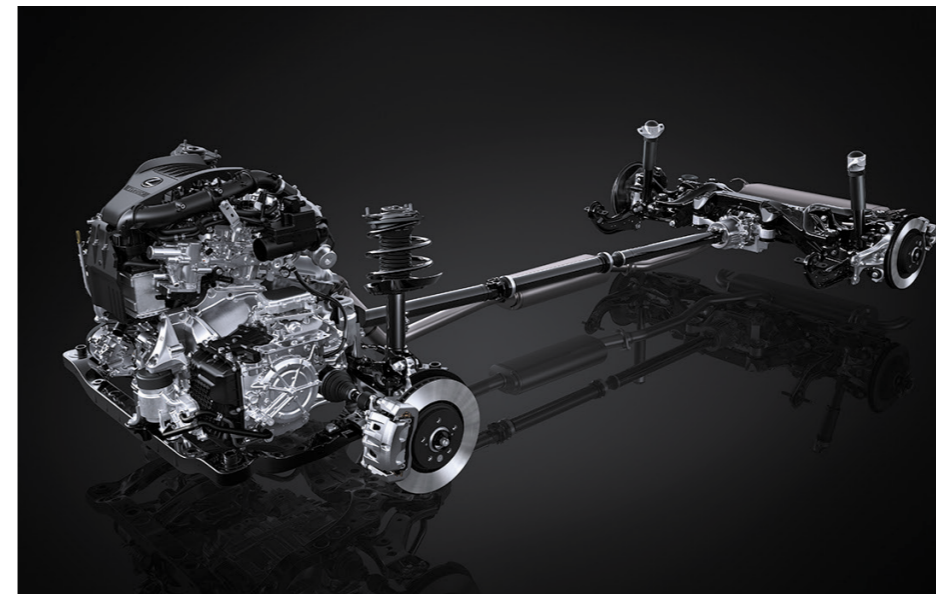

Electronically Controlled Full-time AWD

Electronically controlled full-time AWD has been adopted in turbo models to optimize the front/rear drive torque distribution in keeping with the driving conditions, allowing the driver to confidently control the vehicle as intended. The system provides exhilarating yet refined control from normal to aggressive driving, allowing control using the accelerator for smooth vehicle behavior from corner entry to exit, enabling turns faithful to steering operation, and providing strong transmission of traction on various road surfaces. In addition, the AWD system's front/rear torque distribution is shown in the center display, contributing to intuitive understanding of operating status and peace of mind.*2

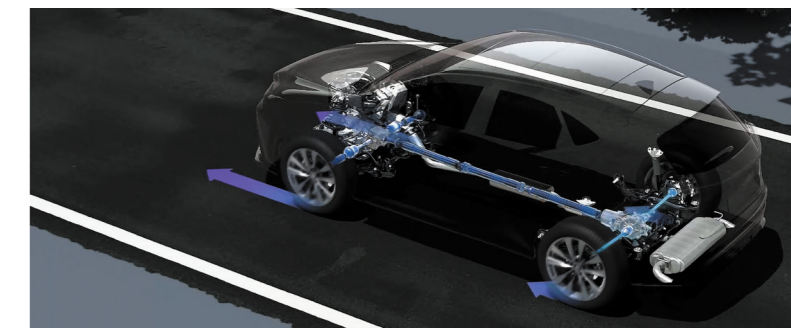

Electronic Control Standby AWD

Information from various sensors is used to automatically control the front-rear torque distribution in ratios between 100:0 and 50:50. In addition to road surface friction estimation control based on existing sensor information, snowy road information acquired from a camera enhances the accuracy of judging road conditions, enabling more confident driving in conditions such as snowy roads. As with the electronically controlled full-time AWD, the system's front/rear torque distribution is shown in the center display, contributing to intuitive understanding of operating status and peace of mind.

*1 VVT-iE: Variable Valve Timing-intelligent by Electric motor. *2 AWD: All Wheel Drive.

Note: Vehicles pictured and specifications detailed in this catalog may vary from models and equipment available in your area. Please inquire at your local dealer for details on the availability of features.

Body and mechanism: Contributing to outstanding ride comfort and smooth steering feel

High-rigidity, lightweight body

Frame section connections were reinforced and panel joints strengthened by various means, including expanding the area of joints, optimizing the application of bonding technologies and materials in different locations, and the use of high-rigidity foam material in the rear pillars. In addition, a twin hood lock construction design that uses the hood as a rigid member provides excellent front lateral flex rigidity, endowing the NX with exceptional body rigidity. Materials and manufacturing techniques were reviewed to reduce the weight of the body and outer panel parts, with a priority on higher parts to lower the center of gravity, to help suppress roll while cornering.

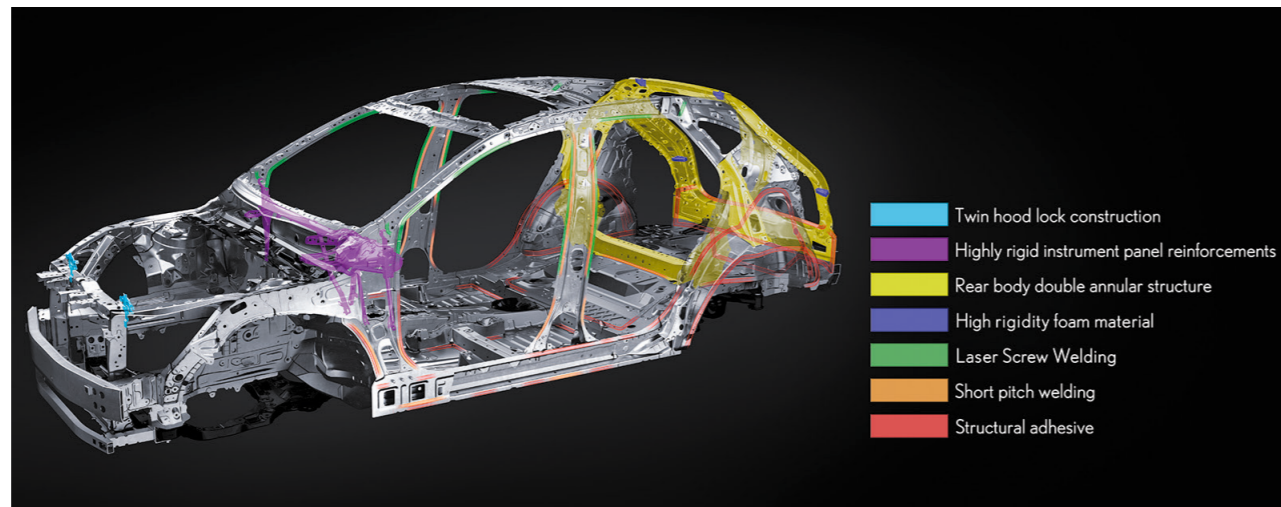

Suspension (Front/rear)

Lexus aimed for a composed steering feel with clear straight-line stability, and a flat, road-hugging posture. Suspension bushes feature low-torsion characteristics, while the shock absorbers reduce shock and vibration to deliver a quality ride. When turning, the suspension was engineered to yield a clear driving feel in response to steering inputs and broad, reassuring behavior at the limits. Additional enhancements that include high-rigidity/low-friction suspension characteristics, optimal axial force (friction) of the shock absorbers at very low speeds, and high roll rigidity, help realize a smooth, linear initial response to steering operation; a stable, visually appealing stance during cornering; and effective steering and stable control at the limits.

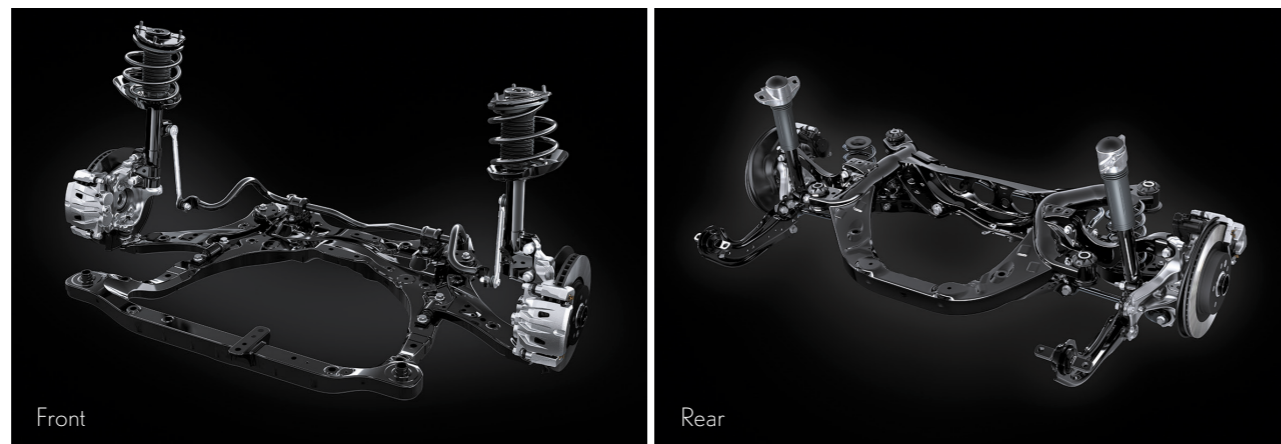

Dynamic performance that contributes to driving performance and a quiet cabin during high-speed driving

Aerodynamic performance

Development of the NX's aerodynamics focused on control technologies that utilize aerodynamic forces on the front, sides, rear and even under the floor to enhance driving performance. For example, the front bumper was shaped to generate longitudinal vortices to control the flow of air along the sides of the vehicle, while a flush belt molding helps generate a strong and stable vortex on the upper surface to regulate airflow, contributing to exceptional handling stability. Additional enhancements to control air flow across the vehicle include fins on the rear bumper to suppress turbulent airflow behind the rear tires, openings in the rear bumper to reduce up and down movement on the springs, and an engine under cover that contributes to excellent straight-line stability during high-speed driving.



Quietness

Development of the NX focused closely on providing the exceptional quietness embedded in Lexus DNA.

Enhancing quietness while high-speed cruising

To reduce variations in noise levels due to varying vehicle speeds while driving, we focused on the low to mid frequencies which cause a high level of cabin noise. In addition, we implemented vibration-damping measures on panels such as the hood and side doors, which can vibrate noticeably because of fluctuations in air pressure during high-speed cruising.

Enhancing quietness during wet weather driving

To realize a comfortable cabin space regardless of the driving conditions, measures to reduce the splashing noise during wet weather driving focused on areas around the tires and under covers.

Hub bolt fastening construction

Adopting a hub bolt fastening construction enhances high axle rigidity and reduces unsprung weight, contributing to a crisp steering feel with clear feedback and high-quality ride comfort. A black coating enhances the appearance of the wheels and ornamentation.



Lexus Electrified _____ LEXUS NX



Note: Vehicles pictured and specifications detailed in this catalog may vary from models and equipment available in your area. Please inquire at your local dealer for details on the availability of features.

Plug-in hybrid: Realizing outstanding EV (Electric Vehicle) driving performance, acceleration, and quietness

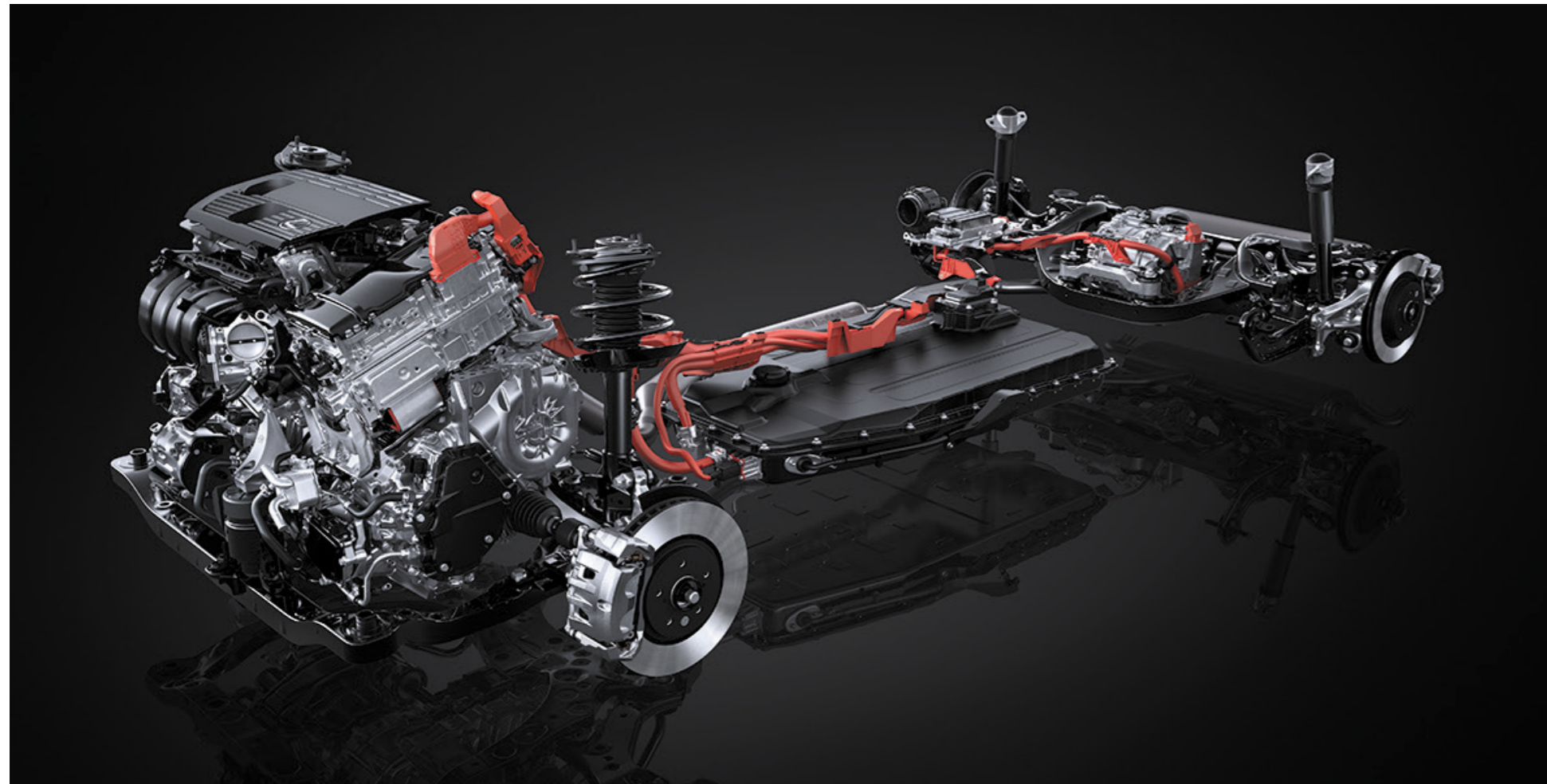

Plug-in Hybrid System

The plug-in hybrid system combines a highly-efficient 2.5-liter inline 4-cylinder engine, high-capacity lithium-ion battery, and high-output motor to realize outstanding EV driving performance, acceleration, and quietness. With the excellent output of the high-capacity lithium-ion battery, the system achieves EV output equivalent to a 2.0-liter engine. In addition to the excellent EV driving range characteristic of a PHEV, the system also delivers ample power for general driving. Switch operation enables changing from the default EV mode to Auto EV/HV mode or HV mode. Hybrid output combines engine and battery output to realize a linear and powerful acceleration feel in which engine rpms increase in line with vehicle speed. Furthermore, even after the engine starts, battery output is utilized to keep the engine speed low, reducing engine noise during acceleration. As a result, the system realizes the overwhelming quietness of an EV.*

Lithium-ion battery

The battery pack uses high-capacity lithium-ion battery cells that yield total battery energy of 18.1kWh, realizing both excellent EV driving range and dynamic driving performance. The battery incorporates a battery cooling system that uses air conditioner coolant, as well as a battery heating system for use during cold weather. Locating the battery pack under the cabin floor facilitates a spacious cabin and lowers the vehicle's center of gravity.

2.5-liter engine

The 2.5-liter inline 4-cylinder engine was optimized for a plug-in hybrid vehicle to deliver a sophisticated balance of high output and outstanding fuel economy. A high compression ratio, long stroke, high-efficiency intake ports that create strong tumble flow, increased intake air flow, and direct injectors contribute to fast, stable combustion. It also features VVT-iE, which controls intake valve timing to improve response.

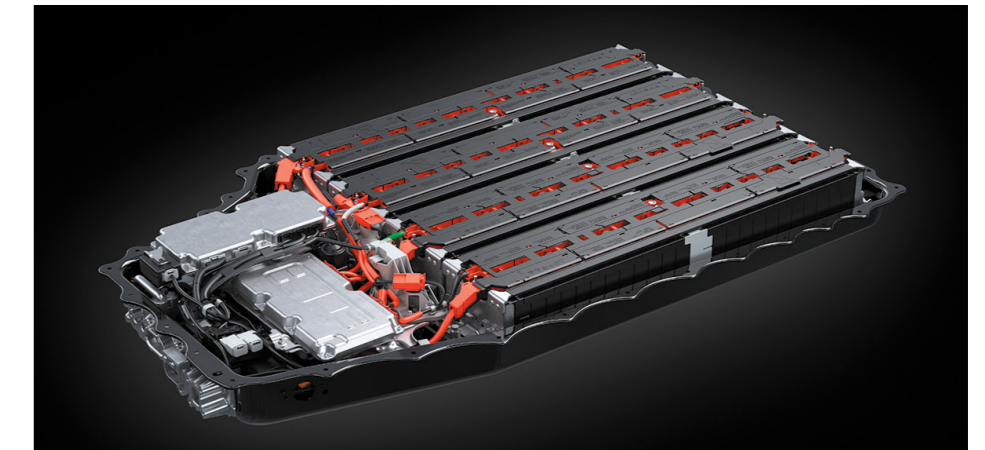

Lithium-ion battery

Transaxle

A hybrid transaxle developed for the 2.5-liter inline 4-cylinder engine combines the high-efficiency engine with a new gear train and high-output motor to deliver exceptional fuel economy, quietness, and driving performance.

PCU (Power control unit)

Separating the DC/DC converter previously built into the hybrid PCU (located under the second row seats) and adding a boost converter, realizes high output in a compact size. It also enables the PCU to be mounted directly above the transaxle.

Note: Vehicles pictured and specifications detailed in this catalog may vary from models and equipment available in your area. Please inquire at your local dealer for details on the availability of features.

Select driving modes to suit varying conditions

The PHEV offers four driving modes.

1. EV mode

Set as the default mode to take advantage of the high output of the high-capacity lithium-ion battery, EV mode is recommended for pure EV driving enjoyment. The vehicle is only powered by the motor without the engine starting, even if the accelerator is fully depressed. EV mode offers clean driving performance without any emissions sufficient for daily travel, though the engine will start if the battery charge is low.

2. Auto EV/HV mode

Select when you require temporary engine power. While the vehicle operates primarily as an EV, the engine will start to provide momentary power when the accelerator is depressed deeply, providing the dynamic acceleration of the motor and engine working together.

3. HV mode

Select when you want to maintain the battery charge level, the engine starts and stops in response to the system status. When the battery charge is low, it automatically switches to HV mode, then switches back to EV mode or to another mode once the charge level is restored, for example by regenerative braking.

4. Battery charging mode

Select when you want to charge the battery while driving to allow continued EV driving. When the battery charge level falls below the level required for EV driving, a switch allows the battery to be charged using electricity generated by the engine. This mode allows EV driving without external charging.

* This mode is not available under certain vehicle conditions.



Lexus Hybrid Drive: Responding to the driver's intentions

Lexus Hybrid Drive

The 4th generation, large-capacity hybrid system combines a highly-efficient 2.5-liter inline 4-cylinder engine with a high-output motor. It effectively combines a highly responsive engine, lithium-ion battery with enhanced battery performance, and hybrid system control with revised drive force characteristics to realize a high level balance between exhilarating driving performance and excellent fuel economy. Specifically, the drive force characteristics were developed to deliver smooth and direct start-off/acceleration characteristics in the form of linear vehicle G force in response to accelerator operation, and a continuous acceleration feel at mid accelerator operation. It also provides cruising and following characteristics to easily maintain vehicle speed and distances between vehicles.

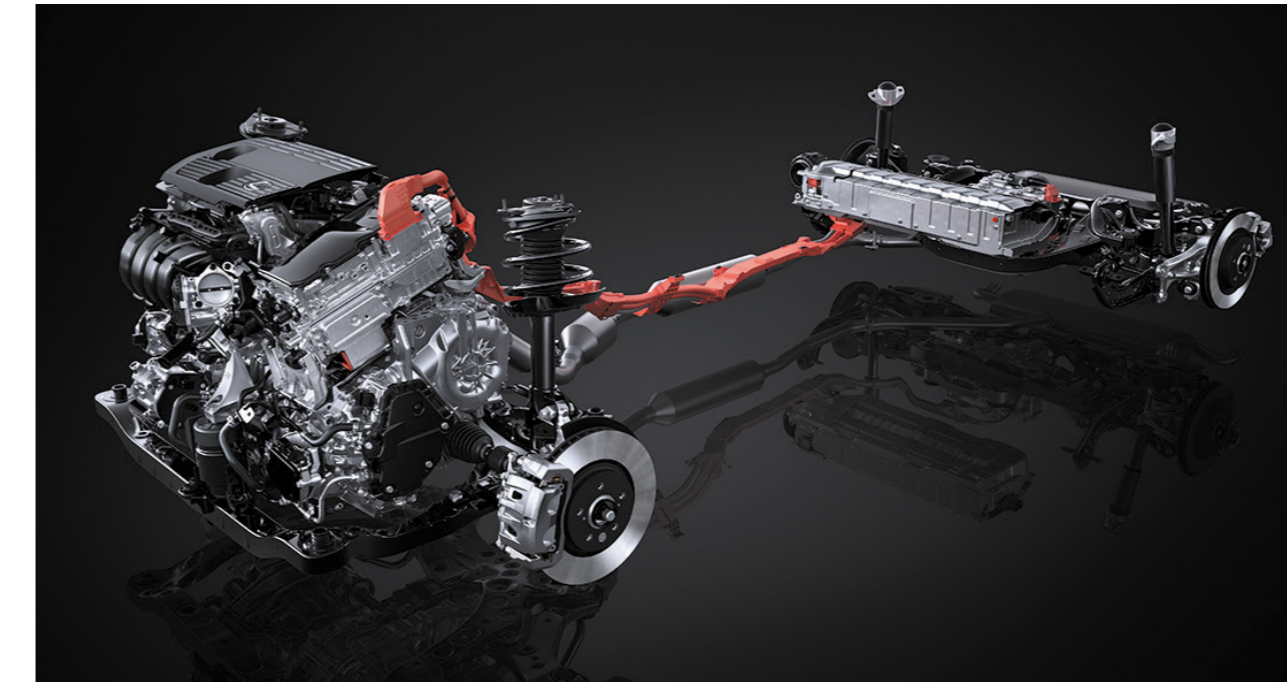

E-Four

E-Four realizes stable driving performance by using the motor to drive the rear wheels when starting off or driving on slippery surfaces such as snow-covered roads. The front-rear power distribution is precisely controlled in ratios between 100:0 and 20:80 to provide excellent acceleration when starting off, and cornering stability in line with the driver's intentions.



Lithium-ion battery

Advanced Technology _____ LEXUS NX

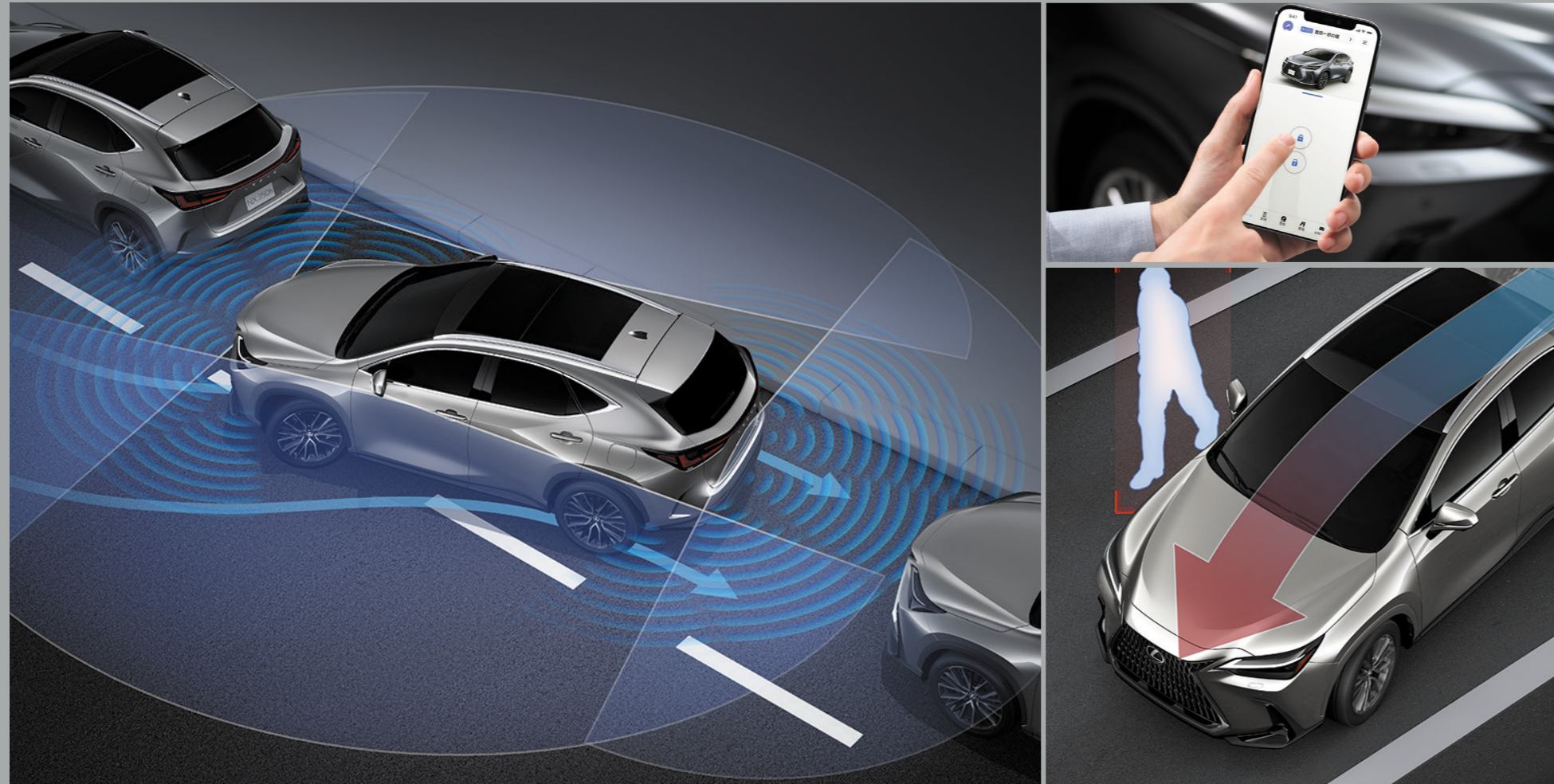

Note: Vehicles pictured and specifications detailed in this catalog may vary from models and equipment available in your area. Please inquire at your local dealer for details on the availability of features.

Pre-Collision System: Anticipating a broad range of scenarios

Pre-Collision System

[Pre-collision Brake Assist with pedestrian (day or night), bicyclist (day or night), and motorcycle (day) detection using millimeter-wave radar and monocular camera sensors]

When the millimeter-wave radar and monocular camera sensors detect a vehicle, pedestrian, bicyclist or motorcycle*¹ ahead and determine that a collision is likely, it alerts the driver with a buzzer and on the display. If the driver activates the brakes, pre-collision brake assist supplements the force being applied to the pedal. If the driver cannot depress the brake pedal, the system automatically activates pre-collision braking to help avoid a collision or mitigate the impact force. If the system determines there is a high possibility of a frontal collision with an oncoming vehicle*², it alerts the driver and activates the brakes to help mitigate injury to people and damage to the vehicle.

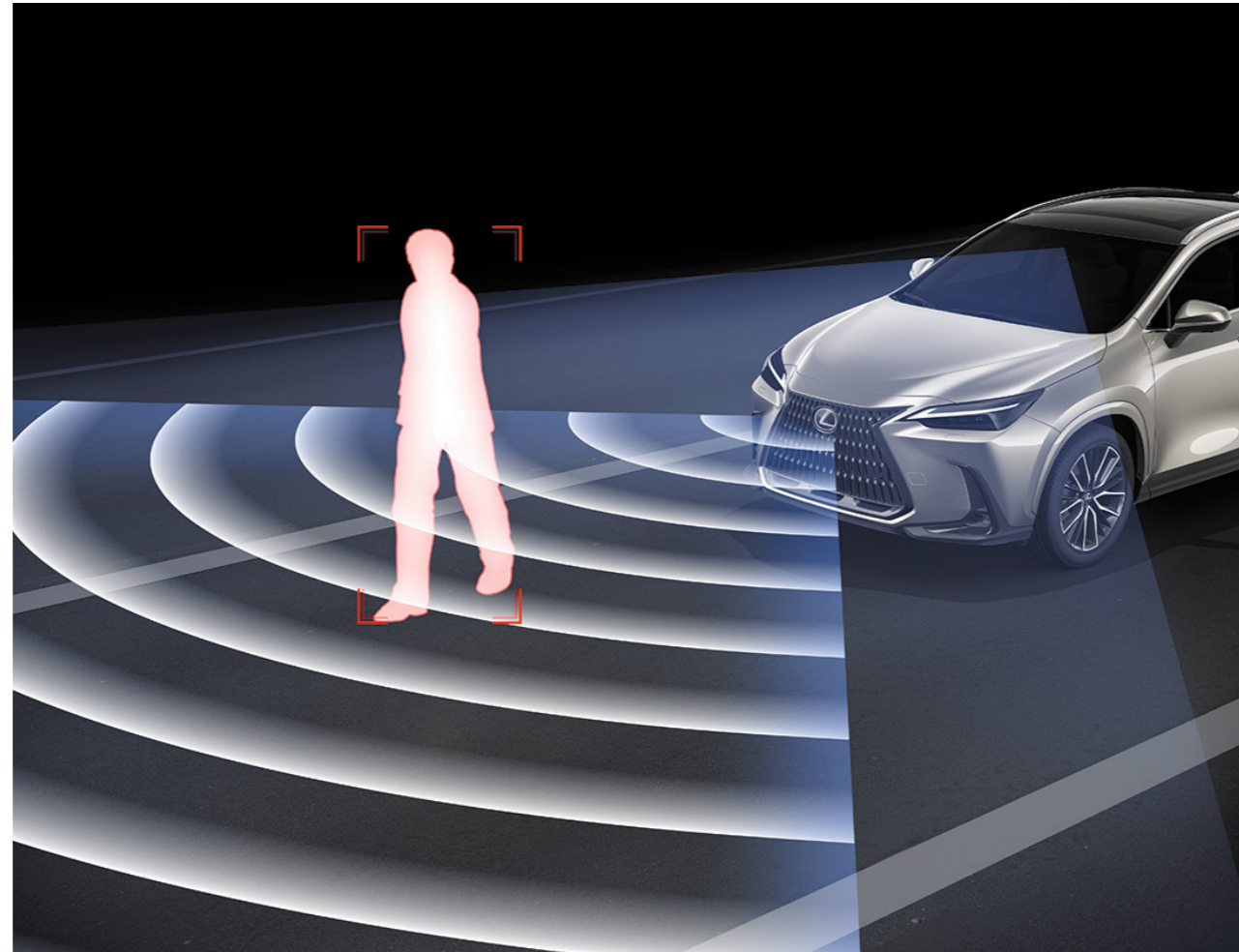

Intersection Assistance (Crossing Vehicle)

In addition to the normal Pre-Collision System operating range, the system also supports collision avoidance with vehicles and motorcycles crossing at intersections. If the system determines that a collision is likely, it alerts the driver and activates the brakes to help mitigate damage.*³

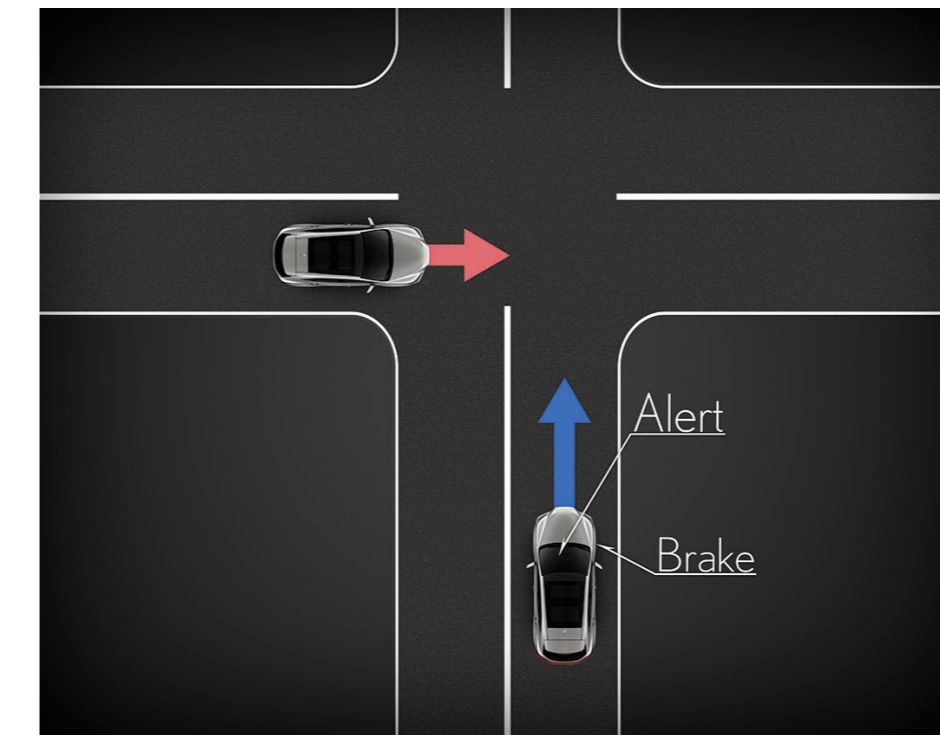

Intersection Assistance (Right/Left Turn)

When turning right or left at an intersection, if the millimeter-wave radar and monocular camera sensors detect an oncoming vehicle (in up to 2 adjacent lanes) going straight when turning right or pedestrians and cyclists crossing from the opposite direction, it alerts the driver and activates the brakes to help avoid a collision and mitigate damage.*³

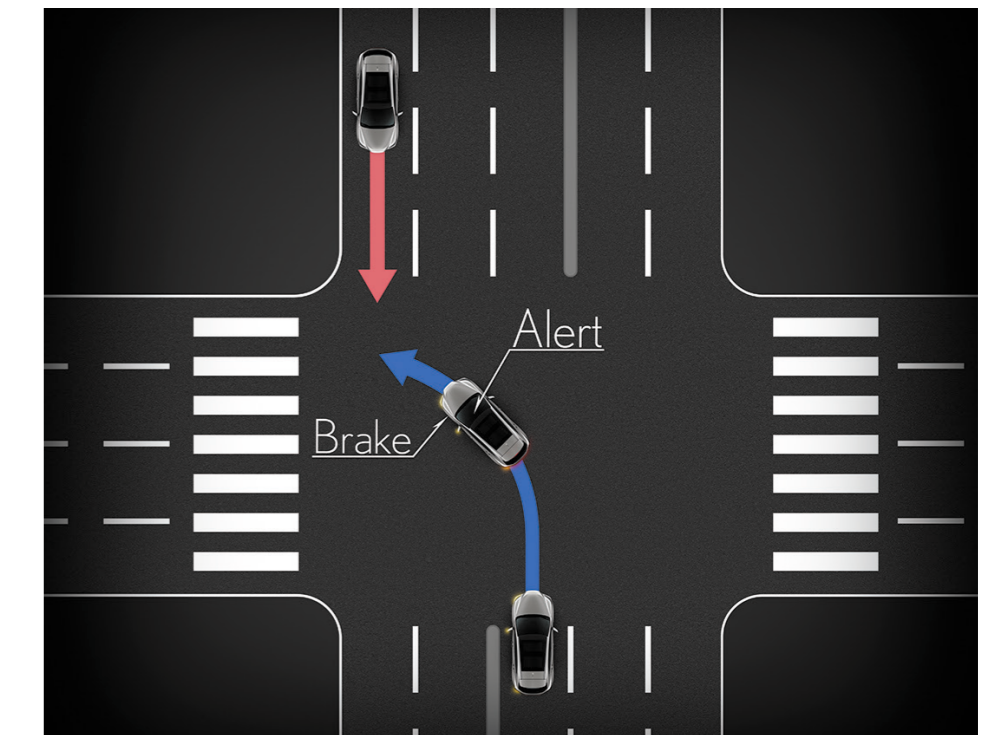

*¹ Pedestrian, bicyclist and motorcycle detection is not available in some markets. Please inquire at your local dealer for details.
 *² Covers frontal collisions and collisions with oncoming vehicles deviating from their lane. Pre-collision Brake Assist does not operate.
 *³ Depending on the intersection configuration, the system may not provide the required support. Pre-collision Brake Assist does not operate.

Note: Vehicles pictured and specifications detailed in this catalog may vary from models and equipment available in your area. Please inquire at your local dealer for details on the availability of features.
 The systems functions may not operate properly depending on the weather, road and vehicle conditions or other factors. Be sure to read the Owner's Manual carefully. Do not overly rely on these systems, as there is a limit to the performance they can provide. The driver is always responsible for paying attention to the vehicle's surroundings and driving safely.

Pre-Collision System: Anticipating a broad range of scenarios

Emergency Steering Assist

If the Emergency Steering Assist system detects a collision with a vehicle, pedestrian or bicyclist ahead is likely, there is sufficient space for the vehicle to be steered within its lane and the driver has begun an evasive steering maneuver, it assists steering to help enhance vehicle stability and prevent lane departure. In addition, even if the driver doesn't move the steering wheel, an optional active steering function supports collision avoidance by steering the vehicle within its lane while gently braking.*¹

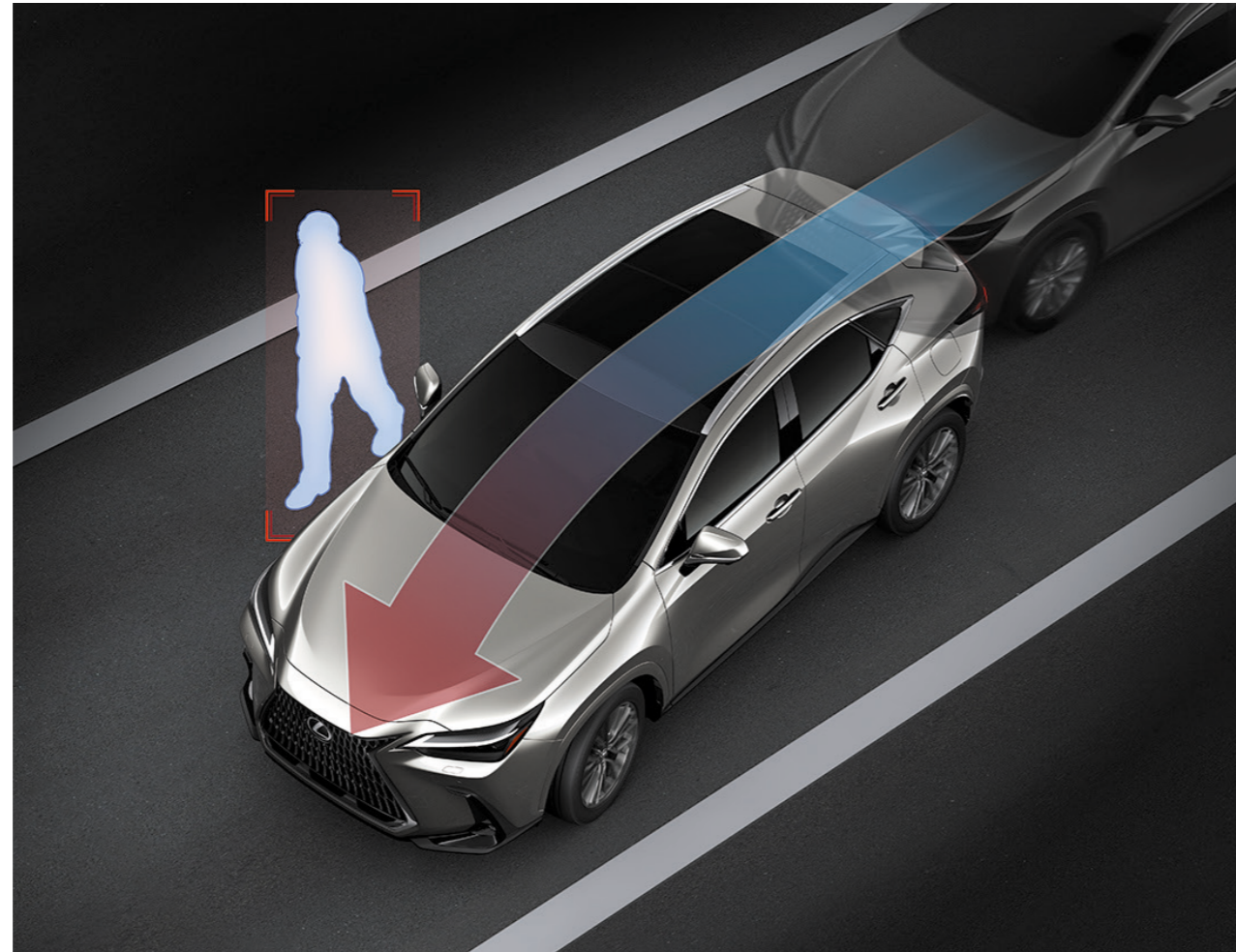

Acceleration Suppression at Low Speed

While driving at low speed, the millimeter-wave radar and monocular camera sensors detect pedestrians, bicyclists, and vehicles in front of the vehicle. If the accelerator is depressed strongly while the vehicle is stopped or traveling slowly with an object in front, the system limits acceleration by reducing engine output or gently braking to help avoid a collision or mitigate damage. In addition, when a collision is avoided and the vehicle stops, braking force is maintained until the driver operates the accelerator or brake.*²

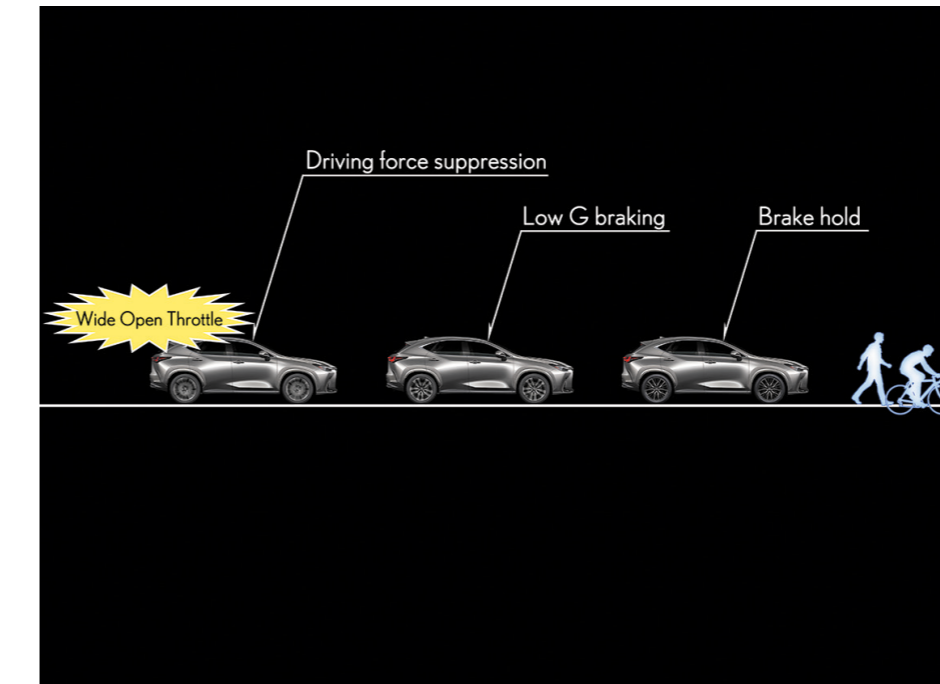

FCTA (Front Cross Traffic Alert)

If the system detects a vehicle approaching from the front left or right when entering an intersection, it will attract the driver's attention with an animated warning in the color head-up display showing the direction the vehicle is approaching from. If the driver continues to proceed despite the approaching vehicle, it will further prompt the driver with a buzzer and warnings on the display.

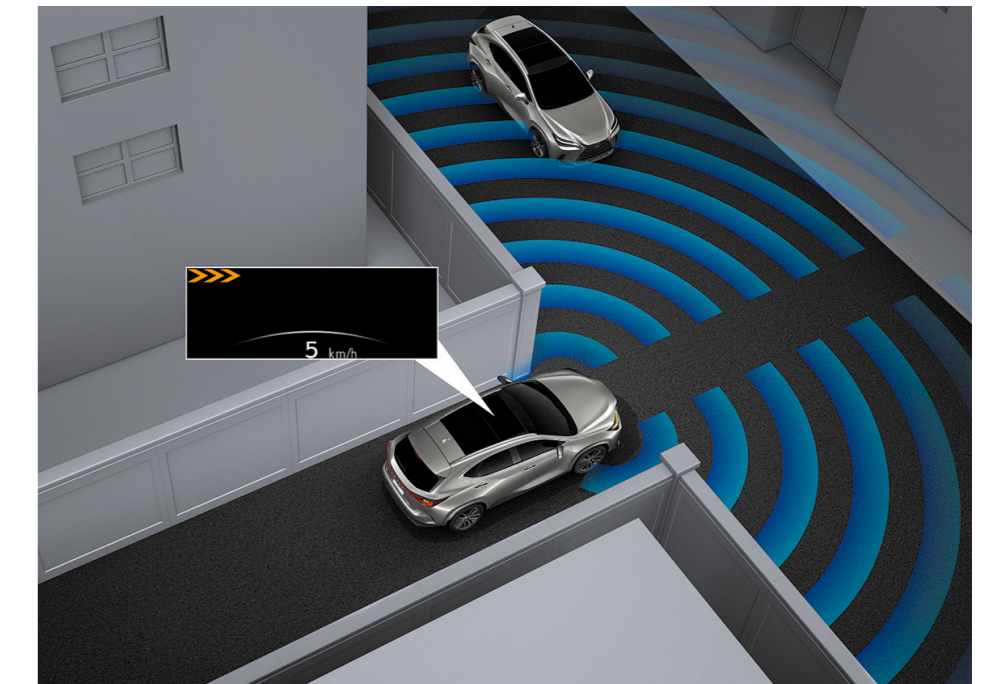

*¹ System may not operate if it determines there is insufficient evasion space or an obstacle within the evasion space, or objects with a certain lateral speed such as pedestrians crossing.
*² This function is not an alternative for the Parking Support Brake.

Note: Vehicles pictured and specifications detailed in this catalog may vary from models and equipment available in your area. Please inquire at your local dealer for details on the availability of features. The systems functions may not operate properly depending on the weather, road and vehicle conditions or other factors. Be sure to read the Owner's Manual carefully. Do not overly rely on these systems, as there is a limit to the performance they can provide. The driver is always responsible for paying attention to the vehicle's surroundings and driving safely.

Advanced Dynamic Radar Cruise Control

Dynamic Radar Cruise Control (With full speed range)

In addition to maintaining a constant speed, Dynamic Radar Cruise Control uses the millimeter-wave radar and monocular camera sensors to detect a vehicle driving ahead and maintain an appropriate distance between vehicles. Furthermore, when approaching and driving through a curve, a Curve Speed Reduction Function decelerates the vehicle, reducing the need to cancel Dynamic Radar Cruise Control operation, enhancing the driver's convenience.



LDA, LTA, and LCA: Providing more fine-grained assistance

LDA (Lane Departure Alert)

The LDA system warns the driver if the vehicle may deviate from the current lane or course, and may also assist steering operation to help avoid deviation.

LTA (Lane Tracing Assist)

When driving on expressways or automobile-only roads with lane lines using Dynamic Radar Cruise Control, the system helps assist the steering operation required to keep the vehicle in its lane. Enhanced recognition and control performance enables assistance on gentle curves, smoothly keeping the vehicle in the center of its lane with minimal swaying.



LCA (Lane Change Assist)

While driving on highways and automobile-only roads with LTA activated, LCA assists steering operations to change lanes and monitoring vehicles in the target lane. LCA uses driver activation of the turn signal lever as the cue to engage lane change support. After the lane change is completed, the turn signal lamp automatically turns off.

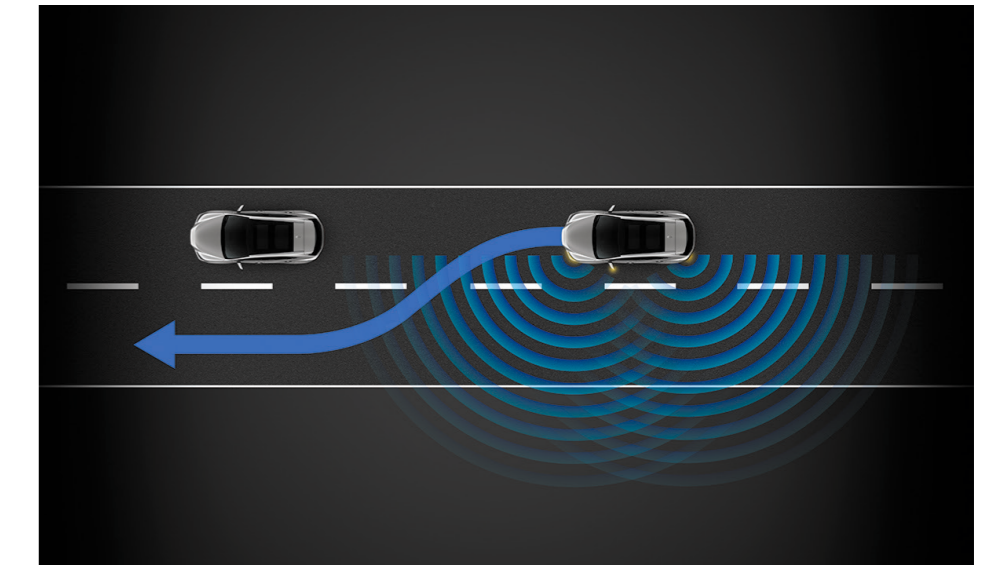

Note: Vehicles pictured and specifications detailed in this catalog may vary from models and equipment available in your area. Please inquire at your local dealer for details on the availability of features.
The systems functions may not operate properly depending on the weather, road and vehicle conditions or other factors. Be sure to read the Owner's Manual carefully. Do not overly rely on these systems, as there is a limit to the performance they can provide. The driver is always responsible for paying attention to the vehicle's surroundings and driving safely.

PDA (Proactive Driving Assist) provides discreet driving support

PDA

Proactive Driving Assist provides discreet support for driving in situations such as on general roads. A combination of three functions provides appropriate support according to driving conditions: steering and deceleration assist in response to pedestrians, bicyclists, and parked vehicles; deceleration assist in response to preceding vehicles; and deceleration assist in response to curves.

Steering and deceleration assist in response to pedestrians, bicyclists, and parked vehicles provides earlier detection of obstacles and assists steering and braking so the vehicle doesn't get too close, helping reduce the risk of an accident.

Deceleration assist in response to preceding vehicles activates to gradually slow the vehicle and maintain a safe distance between vehicles when the driver releases the accelerator.

Deceleration assist in response to curves activates when the system determines the vehicle is traveling too fast to safely negotiate an upcoming curve by gradually braking the vehicle once the driver releases the accelerator.



Closing-up distance

<With deceleration assist activated>

System supports deceleration to prevent the distance between vehicles becoming too close.

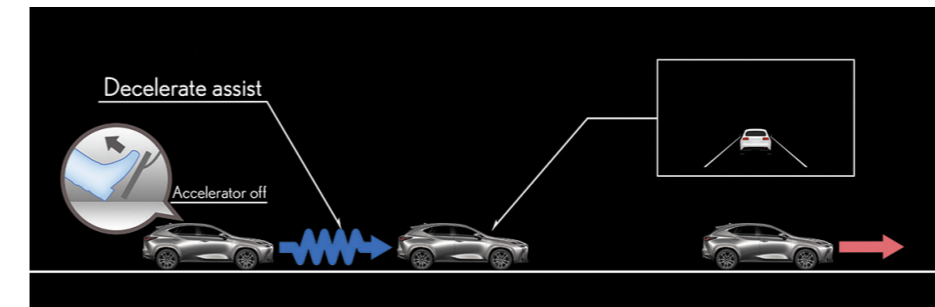

When the distance between vehicles is close

If the close distance between vehicles continues for a period of time, an indicator is shown in the display.

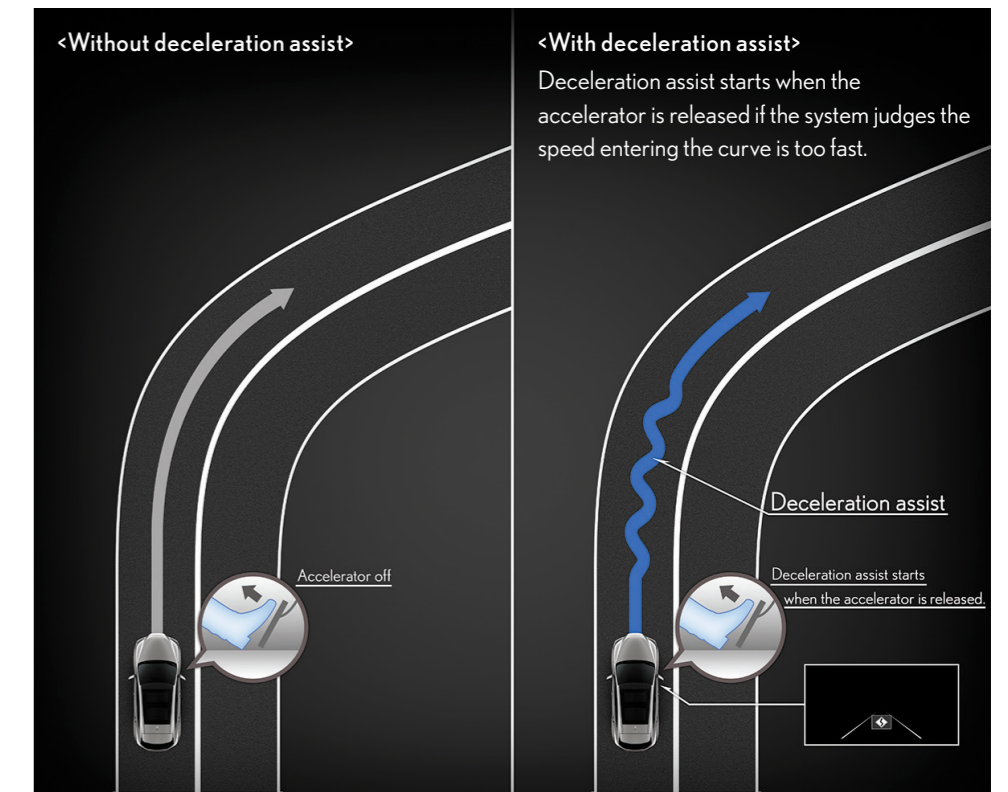
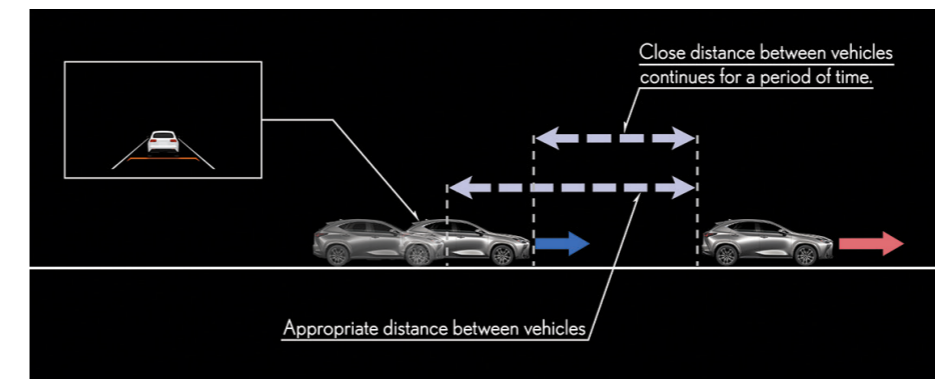

Note: Vehicles pictured and specifications detailed in this catalog may vary from models and equipment available in your area. Please inquire at your local dealer for details on the availability of features. The systems functions may not operate properly depending on the weather, road and vehicle conditions or other factors. Be sure to read the Owner's Manual carefully. Do not overly rely on these systems, as there is a limit to the performance they can provide. The driver is always responsible for paying attention to the vehicle's surroundings and driving safely.

Lexus Teammate Advanced Park: Convenient support for a broad range of parking scenarios

Lexus Teammate Advanced Park

Combining information from cameras and ultrasonic sensors that monitor the vehicle's surroundings, Advanced Park supports appropriate recognition and parking in open parking spots. In addition to automatically controlling steering, accelerating, braking and shift changes, it realizes smooth parking by continuously displaying a bird's-eye view of blind spots and the target car park location.

Parking operation starts smoothly once the driver stops next to the parking space, presses the main switch, checks the vehicle's surroundings and the parking space, and presses the start switch on the display.

Information about the vehicle's surroundings is communicated to the driver in an easy-to-understand manner, showing the locations of obstacles on the display. If there is the possibility of hitting an obstacle, it alerts the driver and helps avoid it by applying brake control.

Advanced Park functions: perpendicular parking (reverse); perpendicular parking (forward); perpendicular exiting (reverse); perpendicular exiting (forward); parallel parking; parallel exiting; memory; and remote control.

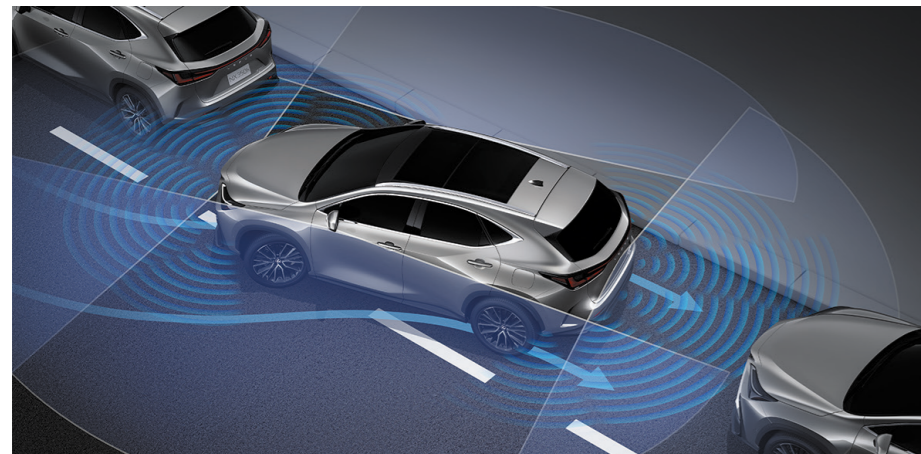

Advanced Park remote control function

Advanced Park is available with a remote control function that enables parking/exiting in a parking space using a dedicated app on your smartphone from outside the vehicle*. The remote control function supports parking/exiting in both parallel and perpendicular parking spaces. In addition, it can move the car backwards or forwards, for example to allow access to the luggage compartment, and easy ingress and egress when parking in unfamiliar and narrow spaces. Designed for ease of use with quick smartphone operation, it starts promptly to eliminate the need to wait.

*Smartphone operation requires the driver to have an Electronic Key.



Realizing smooth, one-action door operation

e-latch

An e-latch system replaces the conventional door latch/unlatch mechanism with an electronic control that opens and closes doors smoothly with no wasted movements, like a sliding shoji paper door. To open a door when getting in, simply press the switch on the inside of the door handle while pulling the handle towards you in the usual way. When getting out, the door opens in a single action by pressing a switch while holding the pull handle.

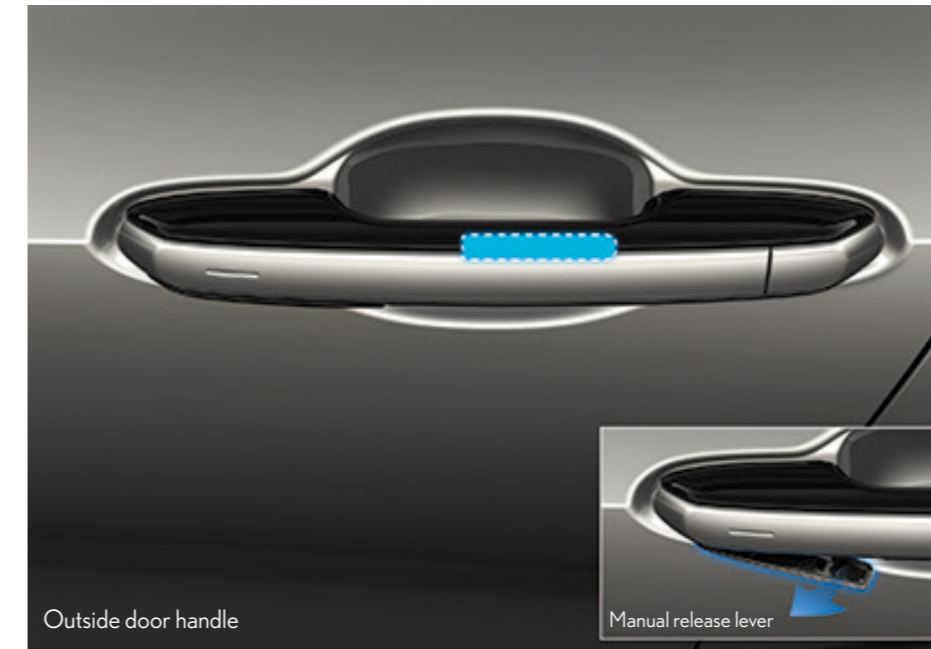

Outside door handle

Manual release lever



Inside door handle

Reliable assistance enhances peace of mind

SEA (Safe Exit Assist) with door opening control

SEA uses the BSM (Blind Spot Monitor System) to detect vehicles (including bicycles) approaching from the rear when exiting the vehicle. If SEA determines a collision with an opened door or exiting occupants is a possibility, an indicator in the door mirror lights up to alert occupants. In addition, if an occupant tries to open a door, the e-latch system cancels door unlatch operation. Occupants are alerted by flashing indicators in the door mirror, the multi-information display, and a buzzer.



The Digital Key opens up a convenient mobile lifestyle

Digital Key

Installing the dedicated Digital Key app on a smartphone lets you use the smartphone instead of the smart key. When carrying the smartphone, you can lock/unlock the doors, and start the engine. The Digital Key can be transferred between smartphones, making it easy for friends or family members to use the vehicle, even when parked in a remote location. A single smartphone can support digital keys for multiple cars.



Using as Smart Entry & Start System

Operation is possible simply by carrying a smartphone (active smartphone screen not required).

- Lock/unlock
- Engine start



Using as wireless key

Operation via smartphone screen

- Lock/unlock

F SPORT

LEXUS NX



Note: Vehicles pictured and specifications detailed in this catalog may vary from models and equipment available in your area. Please inquire at your local dealer for details on the availability of features.

Exclusive features including 20-inch aluminum wheels, lower bumper spoilers, and front side garnish exude a sporting presence.



A_F SPORT emblem / B_Fender arch moldings / C_Grille / D_Lower bumper spoiler / E_Garnish / F_Roof rails (black) / G_Exclusive 20-inch aluminum wheels

Performance dampers and AVS (Adaptive Variable Suspension system) enhance exhilarating F SPORT driving performance

Exclusive F SPORT tuning

F SPORT front and rear performance dampers quickly absorb flex and minute vibrations in the body while driving, to further sharpen handling characteristics, and enhance ride comfort and quietness. In addition, linear solenoid type AVS provides excellent damping force switching response. It contributes to shock isolation and a flat ride posture even on roads with large undulations and small rough areas, enhancing the excellent steering response and stability, while contributing to outstanding ride comfort.

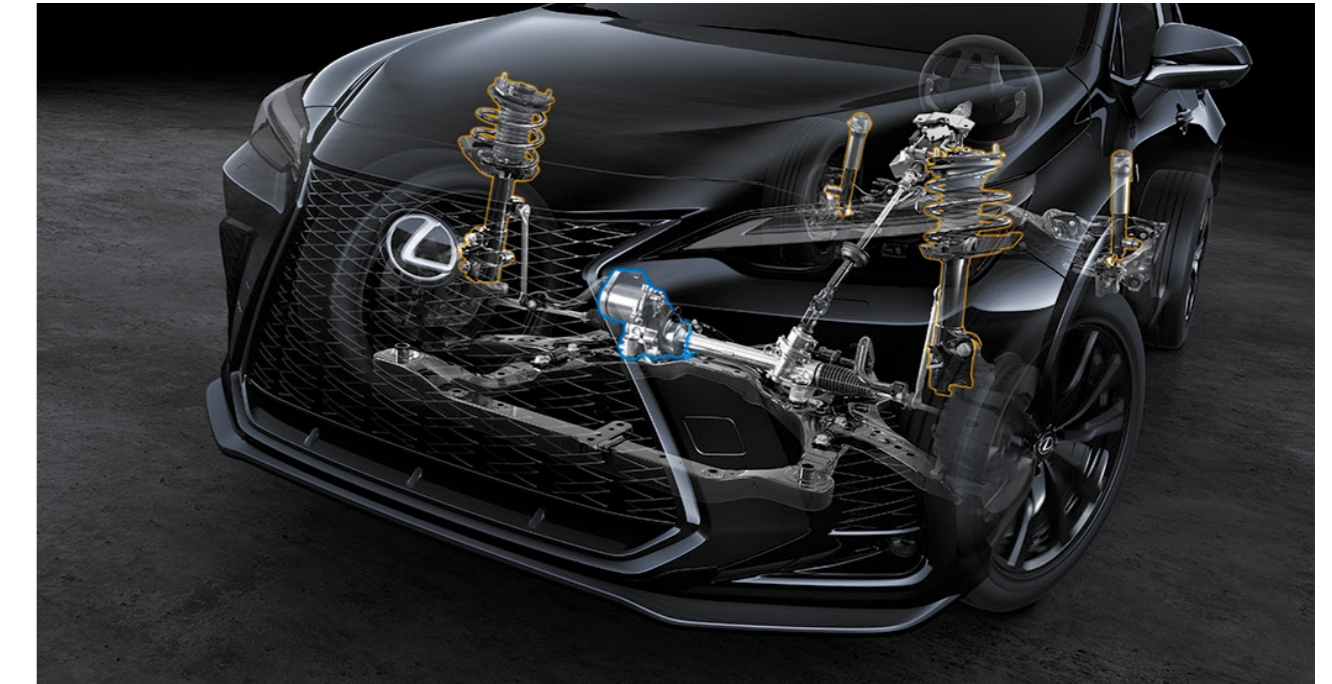

Heightening distinctive F SPORT individuality

Exclusive F SPORT interior

The F SPORT steering wheel, front seats, aluminum pedals, shift lever and exclusive enhancements boost sports driving control and enjoyment.



Exclusive F SPORT seats

The F SPORT seats are specially designed to provide the firm support required for exhilarating sports driving.



Exclusive F SPORT meter

In SPORT S+ mode the F SPORT meter features a racing specification layout.



Exclusive F SPORT steering wheel

The steering wheel features a grip cross-section designed to meet the demands of sports driving.



Other Equipment

LEXUS NX



Comfort features

Panoramic roof/moon roof

The panoramic glass roof features a sliding design. On the moon roof, the inner glass unit slides open, enabling a more expansive opening when the roof is fully open.



Panoramic roof



Moon roof

A cockpit layout focused on driving

Shift lever and shift knob

The shift lever is designed to provide a satisfying operating feel with gating that clicks sharply into position. With a short stroke and reduced peak load during shift operation, the lever feels light and easy to use. The shift knob was developed to provide the soft, moist feel of genuine leather, with a shape that is easy to grip and use.



Center console features

Cupholders: With a 75mm diameter base, the cupholders can accommodate a range of cups and tumblers. With non-slip mats in the bottom, you can open plastic drink bottles with one hand while driving, without looking away from the road.

Slide-open tray: The storage and charging tray integrated in the front of the center console features a simple slide opening, helping to minimize the eye movement required to access the tray, supporting focused concentration on driving.

Double door console box lid: The lid is designed to provide easy access to the console box from both the driver's seat and the passenger's seat.



Slide-open tray

A large, easily-accessible luggage space

Luggage space

The luggage space provides ample storage space with the rear seats up, and can be expanded as required by folding one or more of the rear seats down. Convenient side nets enable stowing of small items. Two lamps in the deck sides and one in the back door provide good illumination at night. In addition, a 3-way deck board that is easily folded with one hand, lets you change the layout to accommodate different sizes and amounts of luggage. The bifold design of the lightweight tonneau cover provides a wide opening for luggage, and enables easy folding and storage under the floor when not in use.



Hands-free power back door

Even if both hands are full, when carrying the Electronic Key you can open and close the back door automatically by moving your foot under the rear bumper and out again. Refinements enhance fast, quiet operation, and a buzzer confirms when to move your foot out.



A sound system delivering deep, sharp bass

Mark Levinson Premium Surround Sound System

The Mark Levinson Premium Surround Sound System supports high-resolution audio to create a performance space that exceeds conventional CDs by reproducing the balanced and detailed expression of a live performance, such as the soft sounds produced by string instruments. The Mark Levinson PurePlay concept is used to achieve pure, distortion-free sound. Matching the heights of 7 Unity speakers and positioning them to surround the cabin creates the feeling of a live stage, with clear and unified mid-high range reproduction throughout the cabin. The system also features QLS (Quantum Logic Surround) sound technology to realize a precise stage feel, localization, and dynamic playback, and Clari-Fi compressed audio source reproduction technology to reproduce sound as close to the original as possible. A 25cm box subwoofer under the rear deck provides deep, crisp and loud bass.

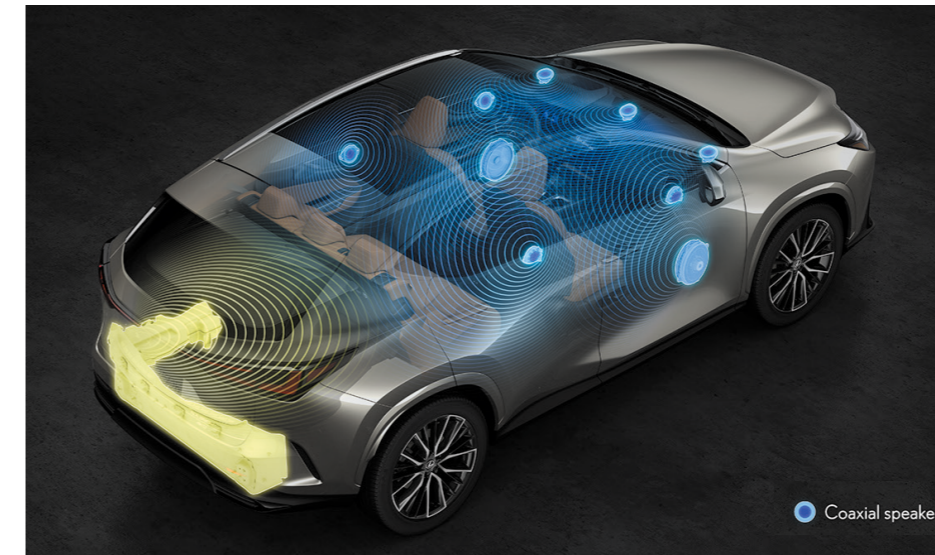

Mark Levinson Premium Surround Sound System

Lexus NX Premium Sound System

The 10-speaker Lexus NX Premium Sound System reproduces your favorite music with a feeling of dynamic realism. The amplifier, capable of playing high-resolution sound sources with more information than a CD, generates a clear mid-high range with heavy and sharp bass. The use of bass reflex speakers with a broad playback band despite their small diameter, allows optimal placement of speakers for low, mid, and high tones, delivering exceptional surround feel and presence. A 20cm box subwoofer under the rear deck provides deep, crisp and loud bass.

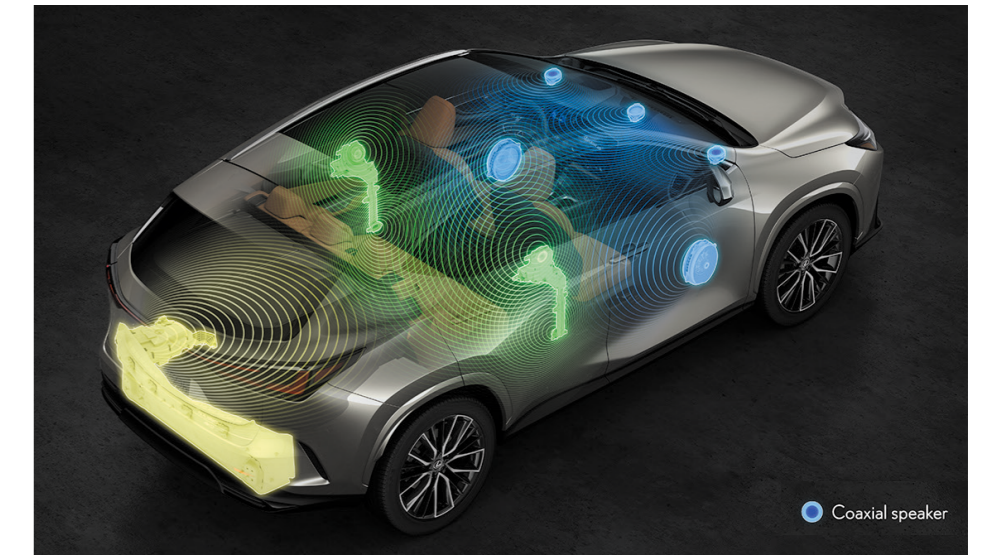

Lexus NX Premium Sound System

Note: Vehicles pictured and specifications detailed in this catalog may vary from models and equipment available in your area. Please inquire at your local dealer for details on the availability of features.

Other Equipment

Drive mode select

Drive mode select provides integrated control of multiple systems, offering enhanced driving pleasure by allowing the driver to select drive modes to suit the situation and their preferred driving style. For models with AVS, drivers can select from Normal, Eco, Sport S, Sport S+ and Custom Mode. In addition, Custom Mode allows the driver to customize their preferred settings for the powertrain, AVS, EPS and air conditioning.



Wireless charging

Enables wireless charging of Qi-compatible smartphones and electronic devices simply by placing them on the charger tray.



Other safety equipment

PKSB (Parking Support Brake)

PKSB (for stationary objects in front, behind, or close to the vehicle) helps to reduce damage by mitigating the severity of collisions caused by mistaken or excessive operation of the accelerator. On vehicles equipped with Advanced Park with Remote Park, the detection of stationary objects has been expanded to right around the vehicle, including the sides. The system monitors the area around the vehicle not only during Advanced Park with Remote Park operation, but also when parking, for example when exiting a garage or backing up, and alerts the driver with indicators and a buzzer if the vehicle is approaching a stationary object. To help reduce damage, it also applies the brakes automatically if the vehicle continues to approach the object.

PKSB (for vehicles approaching from behind) alerts the driver of vehicles approaching from behind when backing out of a parking space, with indicators on the door mirror and center display, and a buzzer. If the system determines there is a high possibility of a collision with a crossing vehicle approaching from behind, it automatically applies the brakes to mitigate injury or damage.

PKSB (for pedestrians approaching from behind) alerts the driver of pedestrians behind the vehicle when backing out of a parking space with an indicator on the touch display and a buzzer. If the system determines there is a high possibility of a collision with a pedestrian behind the vehicle, it automatically applies the brakes to mitigate injury.*¹

SRS airbag system

The front seats are equipped with SRS airbags that deploy in response to impact force from the front of the vehicle. An SRS knee airbag for the driver's seat cushions impact force and disperses it throughout the body by arresting movement of the lower limbs. SRS side airbags and SRS curtain shield airbags protect occupants in a side collision.*²

^{*1} Detection of vehicles and pedestrians approaching from behind while reversing is not available in some markets. Please inquire at your local dealer for details.
^{*2} The SRS airbags are supplemental devices to be used with the seatbelts. The driver and all passengers in the vehicle must wear their seatbelts properly at all times. Never install a rear-facing CRS (Child Restraint System) on the front passenger's seat. For a forward-facing CRS, it is recommended you use it in the rear seats. Please do not use accessories for the seats which cover the parts where the SRS side airbags should inflate. Such accessories may prevent the SRS side airbags from activating correctly, causing serious injury (Lexus genuine seat covers are specifically designed for models equipped with the SRS side airbags. To find out about availability in your area, please inquire at your local dealer). The photo shows all the SRS airbags activated for display purposes only (the SRS side and curtain shield airbags only inflate on the side of the collision in an actual accident). For details on these and other important safety features, be sure to read the Owner's Manual carefully.

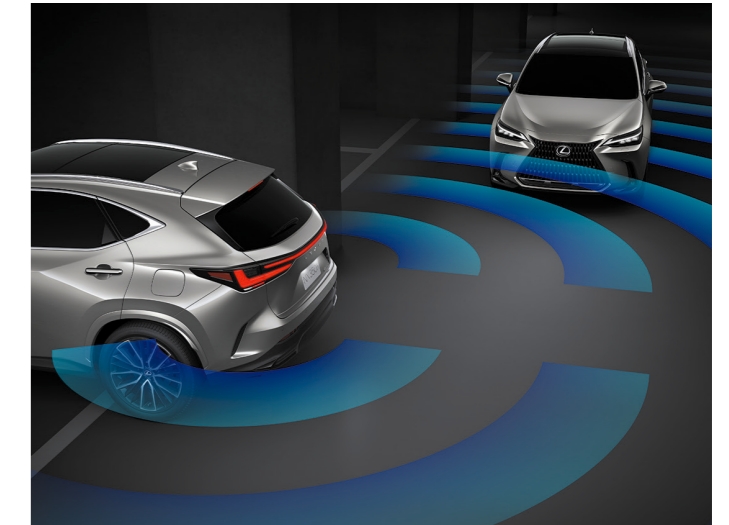

Reducing blind spots and enhancing the field of view

Panoramic View Monitor

Panoramic View Monitor combines video from cameras mounted on the front, sides and rear of the vehicle to display a composite image showing a bird's-eye view of the vehicle, helping the driver to check areas around the vehicle that are difficult to see from the driver's seat.

The monitor offers 3 views: See-through View, looks through the body and seats as if they were transparent; Side Clearance View, lets you check the sides of the vehicle for safe clearance; and Cornering View, helps you avoid hitting obstacles on narrow roads.

The system's enhanced functionality supports voice commands. It also provides assistance when parking and driving in confined spaces by displaying "underfloor" images showing the road under the vehicle and around the tires when Panoramic View, Side Clearance View, or Cornering View is active, and the underfloor, see-through display function is on.*1



Panoramic View and Side Clearance View



Panoramic View and Cornering View

Digital Rear-view Mirror

When switched from optical to Digital Rear-view Mirror mode, the mirror displays real-time images from the back-up camera to provide a wider field of view unobstructed by headrests or passengers' heads, helping to check safety behind the vehicle.

The high-resolution images have natural colors, and also provide clear visibility at night.*2



Digital Rear-view Mirror mode view

*1 The area the cameras can show is limited. Be sure to visually check your surroundings before you proceed. If the underfloor, see-through function is turned on in the center display settings, it will automatically appear when the vehicle starts to move when the Panoramic View Monitor is active.

*2 Always adjust the area the mirror displays before you drive the vehicle for the first time or when the driver changes, while stopped in a safe place. Never adjust the display while driving. Failure to adjust the display area may cause a double image. If the display is difficult to see due to reflection from external light when driving models equipped with a moon roof, close the sunshade. It may take time to focus on the display depending on your age and physical condition. In addition, foreign matter such as water drops, snow, or mud may prevent images from being displayed clearly. In this case, switch the mirror to optical mode before driving. In areas where the surrounds are dark, digital signal processing enhances the brightness to boost visibility. It may also cause the digital display monitor to flicker.

EXTERIOR COLORS



White Nova Glass Flake <083> (F SPORT)



Sonic Quartz <085>



Sonic Titanium <1J7>



Sonic Chrome <1L1>



Black <212>



Graphite Black Glass Flake <223>



Madder Red <3T2>



Blazing Carnelian Contrast Layering <4Y1>



Terrane Khaki Mica Metallic <6X4>



Heat Blue Contrast Layering <8X1> (F SPORT)



Celestial Blue Glass Flake <8Y6>

WHEELS



18-inch aluminum wheels
(Dark Gray Metallic)



20-inch aluminum wheels
(Sporty, Dark Gray Metallic)



20-inch aluminum wheels
(High, Dark Gray Metallic)



20-inch aluminum wheels
(High, Premium Metallic)



20-inch aluminum wheels
(F SPORT, Black)



20-inch aluminum wheels
(F SPORT, Super Gloss Black Metallic)

INTERIOR COLORS



Black & Rich Cream



Hazel



Black



Dark Rose



Flare Red (F SPORT)



White (F SPORT)



Black (F SPORT)

INTERIOR TRIM



Ash (Open Pore Finish/Sumi Black)



3D Cutting Black



Micro Dot Piano Black



Dark Spin Aluminum (F SPORT)

INTERIOR COLORS	SEATING MATERIAL/TRIM				
	Genuine Leather	Synthetic Leather	L-fineskin & Synthetic Leather	Genuine Leather (F SPORT package)	Synthetic Leather (F SPORT package)
	Ash (Open Pore Finish/Sumi Black)	3D Cutting Black	Micro Dot Piano Black	Dark Spin Aluminum	
Black & Rich Cream	●	●	-	-	-
Black	●	●	●	-	-
Dark Rose	●	●	●	-	-
Hazel	●	●	-	-	-
Flare Red	-	-	-	●	●
White	-	-	-	●	●
Black	-	-	-	●	●

● Available combination.

Note: Vehicles pictured and specifications detailed in this catalog may vary from models and equipment available in your area. Please inquire at your local dealer for details on the availability of features.

MAIN FEATURES <NX450h+/NX350h/NX350/NX250>

EXTERIOR

- Windshield green glass; IR (Infrared Rays)-cut and UV-cut function
- Front door window glass; UV-cut function
- Rear door, back door and rear quarter window glass; UV-cut function
- Moonroof; power tilt/slide, one-touch mode with jam protection system
- Panoramic roof; power sunshade, one-touch mode with jam protection system
- Door mirrors; LED side turn signal lamp, power folding, interlink with reverse gear, wide view
- Door handles; foot area illumination
- Exclusive front and rear bumpers, front mesh grille, roof rails, front fender emblems, fender arch moldings and aluminum wheels (F SPORT package)
- EMT (Extended Mobility Tire)

INTERIOR

- Optitron meters
- 4.2-inch color TFT (Thin Film Transistor) multi-information display
- Color head-up display; touch tracing operation
- Center console box
- Vanity mirrors and lamps (Front seats)
- Cupholders (Front and outboard rear seats)
- Door pockets (Front and rear doors); bottle holders
- Wireless charger
- Lexus Climate Concierge
- Auto air conditioning system; independent temperature controls for front seats, clean air filter with pollen and odor removal function
- Luggage space; 3-way deck board, foldable tonneau cover
- Exclusive front seats, trim, steering wheel, shift lever, meters, aluminum pedals and scuff plates (F SPORT package)

OPERATION

- Advanced Park; remote control function
- Power tilt and telescopic steering column; auto-away/auto-return function
- Steering wheel control switches
- Hybrid Sequential Shift Matic <NX350h>
- Drive mode select
- Position memory switches (Front seats); 3-memory
- Outside and inside door handles; e-latch system
- Digital Key
- Smart Entry & Start System
- Card Key
- Panoramic View Monitor
- Lexus Parking Assist Monitor; wide back view
- Lexus parking assist-sensor
- Hands-free power back door; close & lock switch

NAVIGATION AND AUDIO

- Lexus Navigation System
- 14-inch (or 9.8-inch) Lexus Display Audio
- 14-inch EMV (Electro Multi-Vision) display; Apple CarPlay and Android Auto compatible
- Lexus NX Premium Sound System; AM/FM radio, 10 speakers (or 8 speakers), MP3 and WMA (Windows Media Audio) play compatible, DSP (Digital Signal Processor), ASL (Automatic Sound Levelizer)
- Mark Levinson Premium Surround Sound System; AM/FM radio, 17 speakers, MP3 and WMA play compatible, DSP, ASL, Clari-Fi, QLS (Quantum Logic Surround)
- Bluetooth function; hands-free calling, wireless connection with AV-profile compliant player
- 2 USB ports/mini-jack

SEATS

- 8-way power front seats
- Power lumbar support (Driver's seat)
- Ventilated Seats (Front seats)
- Power rear seats

SAFETY

- Lexus Safety System + <Pre-Collision System, Dynamic Radar Cruise Control, LTA (Lane Tracing Assist), LDA (Lane Departure Alert), LCA (Lane Changing Alert), RSA (Road Sign Assist), Speed Limiter, AHB (Automatic High Beam), AHS (Adaptive High-beam System), Emergency Driving Stop System, PDA (Proactive Driving Assist)>
- SEA (Safe Exit Assist) with door opening control
- Blind Spot Monitor System
- PKSB (Parking Support Brake)
- PKSA (Parking Support Alert)
- Drive-start Control
- TRC (Traction Control System)
- VSC (Vehicle Stability Control)
- ABS (Anti-lock Brake System) with EBD (Electronic Brake force Distribution)
- Brake Assist system
- Hill-start Assist Control
- 3-eye Bi-Beam LED headlamps; auto-leveling system
- Bi-Beam LED headlamps; auto-leveling system
- LED turn signal lamps
- LED DRL (Daytime Running Lamp)
- LED front and rear fog lamps
- Automatic anti-glare mirrors (Interior and door mirrors)
- Digital Rear-view Mirror
- Dual-stage SRS (Supplemental Restraint System) airbag (Driver's seat)
- Dual-stage SRS airbag/Single-stage SRS airbag (Front passenger's seat)
- SRS knee airbag (Driver's seat)
- SRS side airbags (Front seats)
- SRS front center airbag (Front seats)
- SRS curtain shield airbags (Front and rear door windows)
- WIL (Whiplash Injury Lessening) concept front seats
- 3-point ELR seatbelts (All seats)
- Pretensioners and force limiters (Front seats)
- Anchor bars for fixing ISOFIX-compliant child seat (Outboard rear seats)
- CRS (Child Restraint System) top tether anchors (Outboard rear seats)
- Security system; alarm, immobilizer system
- AL-TPWS (Auto Location-Tire Pressure Warning System)

SPECIFICATIONS <NX450h+/NX350h/NX350/NX250> FOR NORTH AMERICA

DIMENSIONS & WEIGHT

Overall length:	4,660mm
Overall width:	1,865mm
Overall height:	1,670mm ^{*1} , 1,660mm ^{*2}
Wheelbase:	2,690mm
Tread: Front	1,605mm
Rear	1,625mm
Curb weight:	1,990kg <NX450h+> 1,800kg <NX350h> 1,760kg <NX350> 1,680kg <NX250 4WD> 1,620kg <NX250 2WD>
Gross vehicle weight:	2,540kg <NX450h+> 2,380kg <NX350h> 2,370kg <NX350> 2,265kg <NX250 4WD> 2,205kg <NX250 2WD>

CHASSIS

Suspension:	MacPherson strut type (Front)/ Double wishbone type (Rear), coil springs, gas-filled shock absorbers, stabilizer bar
Steering system:	Rack and pinion. EPS (Electric Power Steering)
Brakes: Front	328mm ventilated discs
Rear	317mm ventilated discs
Minimum turning radius (Tires):	55 liters
Fuel tank capacity:	55 liters
Tires:	235/50R20, 235/60R18

ENGINE <NX450h+>

Type:	2.5-liter, 4-cyl. in-line Twin Cam 16-valve (A25A-FXS, unleaded)
Piston displacement:	2,487cc
Max. output:	135kW/6,000rpm (EEC net)
Max. torque:	229Nm/3,600-3,700rpm (EEC net)
Fuel system:	D-4S (Direct injection 4 stroke gasoline engine Superior version)

ENGINE <NX350h>

Type:	2.5-liter, 4-cyl. in-line Twin Cam 16-valve (A25A-FXS, unleaded)
Piston displacement:	2,487cc
Max. output:	141kW/6,000rpm (EEC net)
Max. torque:	243Nm/4,300-4,500rpm (EEC net)
Fuel system:	D-4S (Direct injection 4 stroke gasoline engine Superior version)

ENGINE <NX350>

Type:	2.4-liter, 4-cyl. in-line Twin Cam 16-valve, turbocharger (T24A-FTS, unleaded)
Piston displacement:	2,393cc
Max. output:	205kW/6,000rpm (EEC net)
Max. torque:	430Nm/1,700-3,600rpm (EEC net)
Fuel system:	D-4ST (Direct injection 4 stroke gasoline engine Superior version with Turbo)

ENGINE <NX250>

Type:	2.5-liter, 4-cyl. in-line Twin Cam 16-valve (A25A-FKS, unleaded)
Piston displacement:	2,487cc
Max. output:	151kW/6,600rpm (EEC net)
Max. torque:	249Nm/5,000rpm (EEC net)
Fuel system:	D-4S (Direct injection 4 stroke gasoline engine Superior version)

MOTORS <NX450h+/NX350h>

Front motor:	Type: Permanent magnet motor
	Max. output: 134kW
	Max. torque: 270Nm
Rear motor:	Type: Permanent magnet motor
	Max. output: 40kW
	Max. torque: 121Nm

Total system output^{*3}:

BATTERY <NX450h+/NX350h>

Type:	Lithium ion
Modules:	
Connection method:	Series
Capacity:	4.3Ah

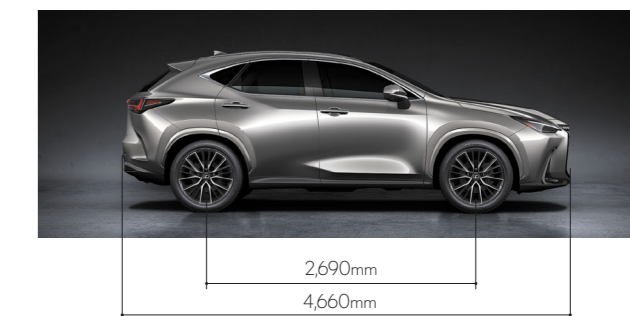

Note: Please inquire at your local dealer for details on the availability of features.

^{*1} 235/50R20 tires. ^{*2} 235/60R18 tires.

^{*3} Total system output from the engine and electric motors (using the battery), based on in-house measurements.

- Addition of extra features may change figures in this chart.
- Toyota Motor Corporation reserves the right to alter any details of specifications and equipment without notice.
- Details of specifications and equipment are also subject to change to suit local conditions and requirements.
- Please inquire at your local dealer for details of any such changes that might be required for your area.
- Note: Vehicles pictured and specifications detailed in this catalog may vary from models and equipment available in your area.
- Vehicle body color might differ slightly from the printed photos in this catalog.